

A fast and simple implementation of Chua's oscillator using a "cubic-like" Chua diode

Keith O'Donoghue* Michael Peter Kennedy† Peadar Forbes‡

Abstract — The nonlinearity in Chua's oscillator is commonly implemented as a three-segment piecewise-linear resistor. The piecewise-linear nature of the element means that the implementation requires a significant amount of circuitry and the speed of operation is limited. The qualitative behavior of Chua's oscillator has also been captured using a smooth cubic nonlinearity; the implementation of the latter also requires a significant amount of circuitry and suffers from limited speed of operation.

This work describes a novel implementation of Chua's oscillator using just four transistors and a battery to produce a cubic-like nonlinearity. The circuit is simple, robust, and capable of operating at frequencies over one thousand times that of the original Chua's oscillator.

1 Introduction

Chua's oscillator [1, 2, 3] is one of the simplest electronic circuits that is capable of producing chaos. It can exhibit a vast array of behaviors including an assortment of attractors, bifurcations and routes to chaos [4]. This makes it an ideal paradigm for teaching about nonlinear dynamics and chaos [5].

Chua's oscillator, shown in Fig. 1, is described by three differential equations:

$$\begin{aligned} \frac{dV_1}{dt} &= \frac{1}{C_1} \left(G(V_2 - V_1) - f(V_1) \right) \\ \frac{dV_2}{dt} &= \frac{1}{C_2} \left(G(V_1 - V_2) + I_3 \right) \\ \frac{dI_3}{dt} &= -\frac{1}{L} \left(V_2 + I_3 R_0 \right), \end{aligned}$$

where $G = \frac{1}{R}$ and $f(\cdot)$ is the driving-point characteristic of the nonlinear resistor, commonly referred to as a "Chua diode".

1.1 Piecewise-linear Chua diode

The original piecewise-linear version of the nonlinearity is given by

$$f(V) = G_b V + \frac{1}{2}(G_a - G_b) \left(|V + E| - |V - E| \right),$$

*Department of Microelectronic Engineering, University College Cork, Ireland, e-mail: k.odonoghue@student.ucc.ie tel.: +353 21 4904572, fax: +353 21 4904573.

†Tyndall National Institute, Lee Maltings, Cork, Ireland. e-mail: peter.kennedy@ucc.ie

‡Analog Devices, Raheen Industrial Estate, Limerick, Ireland, e-mail: peadar.forbes@analog.com

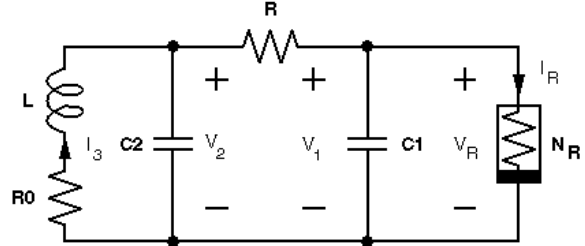

Figure 1: Chua's oscillator.

where G_a and G_b are the slopes of the characteristic in the inner and outer regions, respectively, and the breakpoints are at $\pm E$, as shown in Fig. 2. A robust implementation of the nonlinearity using two op amps and six resistors has already been described [6].

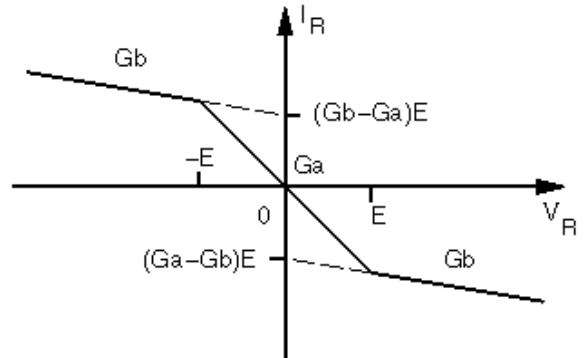

Figure 2: Driving-point characteristic of a piecewise-linear Chua diode.

The piecewise-linear nature of the nonlinearity means that the implementation requires a significant amount of circuitry (the two op amps contain at least twenty transistors) and the speed of operation is limited (to about 10 kHz) by the compensation capacitors in the op amps.

1.2 Cubic Chua diode

The qualitative behavior of Chua's oscillator has also been captured using a smooth cubic nonlinearity:

$$f(V) = G_a V - \frac{G_a}{V_{\max}^2} V^3,$$

where G_a is the slope of the characteristic at the origin and $\pm V_{\max}$ are the outer zeroes, as shown in Fig. 3(a). An implementation of this nonlinearity uses an op amp, two analog multipliers, and five resistors [7].

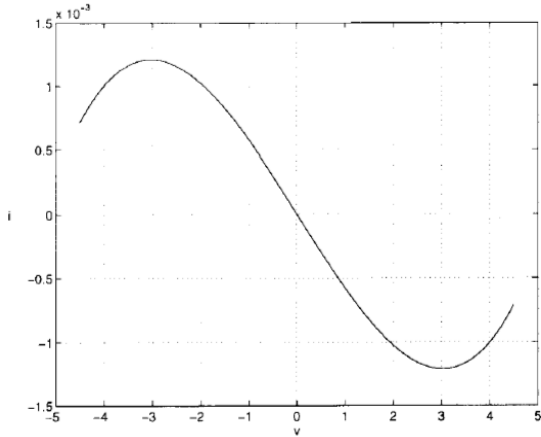

Figure 3: Driving-point characteristic of a cubic Chua diode.

Once again, the implementation of the nonlinearity requires a significant amount of circuitry and suffers from limited speed of operation due to the compensation capacitor in the op amp.

Another implementation of the nonlinearity [8] uses a single-ended differential pair, three current mirrors and a current source to achieve an approximately cubic shaped characteristic.

1.3 Four-transistor “cubic-like” Chua diode

The four-transistor realization of a Chua diode with cubic-like nonlinearity that we propose is shown in Fig. 4. The circuit can be visualised as a pair of cross-coupled CMOS inverters. This subcircuit is characterized by low parasitic capacitance and, when used as a Chua diode, the resulting Chua’s oscillator can operate in the MHz frequency range.

2 Experimental Results

Figure 5 shows the measured driving-point characteristic of the “cubic-like” Chua diode shown in Fig. 4. The Chua diode was constructed with a Dual Complementary Pair Plus Inverter chip¹ powered by a 9 V battery. The slope at the origin of the driving point characteristic, G_a , was measured

¹Fairchild Semiconductor CD4007CN, selected for its low parasitic capacitance.

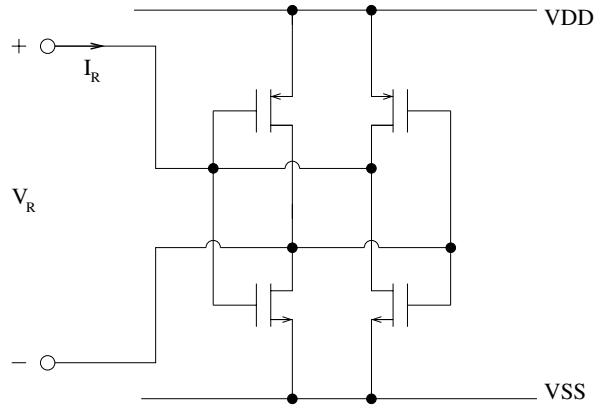

Figure 4: Our four-transistor cubic-like Chua diode

to be -1.375 mS. To achieve maximum speed of operation using this Chua diode, the parasitic capacitance across its terminals was used as the circuit element C_1 in Chua’s oscillator; this parasitic was measured to be 49 pF.

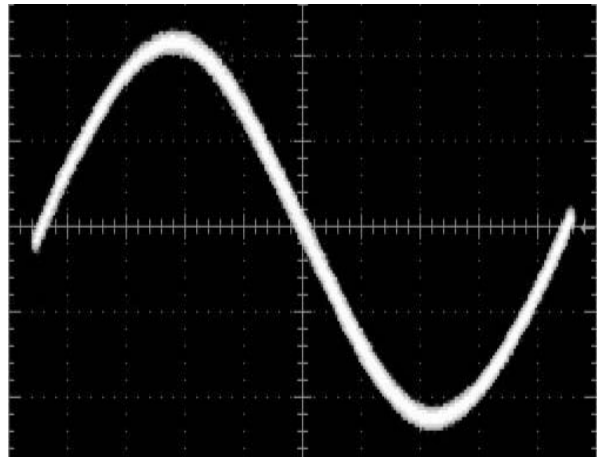

Figure 5: Measured “cubic-like” driving-point characteristic taken from a Tektronix TDS 5054 Digital Phosphor Oscilloscope. Horizontal axis: V_R 2 V/div; Vertical axis: I_R 2 mA/div.

Figure 6 shows a period-4 oscillation as well as single-scroll and double-scroll attractors achieved from a Chua circuit using our new Chua diode. These results were obtained by constructing a Chua’s oscillator using the cubic-like characteristic of Fig. 5 (with $G_a = -1.375$ mS and $V_{\max} = 9$ V) and the component values $C_1 = 49$ pF (parasitic capacitance of the Chua diode), $C_2 = 537$ pF, $L = 29.4$ μ H, $R_0 = 9.17$ Ω and $R = 0.85$ k Ω . This Chua circuit has a period-1 frequency of approximately 1 MHz making it nearly one thousand times faster than any previously described Chua oscillator.

3 SPICE simulations

Figure 7 shows a simulated period-4 oscillation as well as single-scroll and double-scroll attractors obtained in PSpice [9]. We have simulated the Chua's oscillator shown in Fig. 1, using the "cubic-like" Chua diode of Fig. 4 with component values $C_1 = 49$ pF, $C_2 = 537$ pF, $L = 29.4$ μ H, $R_0 = 9.17$ Ω and $R = 0.922$ k Ω (period-4), $R = 0.9$ k Ω (single-scroll) or $R = 0.88$ k Ω (double-scroll); Horizontal axis V_1 ; Vertical axis V_2 . The SPICE Level 3 transistor model parameters are given as follows:

```
.model nmos Level = 3, L = 10u, W = 35.4u,  
VT0 = 1V, lambda = 0, kp = 111u
```

```
.model pmos Level = 3, L = 10u, W = 70.8u,  
VT0 = -1V, lambda = 0, kp = 55.5u
```

4 Conclusion

We have introduced a simple four-transistor implementation of a Chua diode which has a cubic-like driving-point characteristic and low parasitic capacitance. Using this Chua diode, which is both cheap and easy to construct, a Chua's oscillator can be constructed which displays the bifurcations and chaos associated with previous more complex circuits. All results obtained in experiment have been verified with PSpice simulations.

The implementation of Chua's oscillator with our new four-transistor Chua diode is easy. A standard 4007 inverter package is used along with two capacitors, C_1 and C_2 , an inductor, L , and a variable resistor. The circuit is powered with the 9V battery. This circuit can be constructed quickly, easily and for a total cost of less than \$5, making it ideal for those wishing to investigate and demonstrate the behaviour of chaos in electronic circuits. More details on this implementation of Chua's oscillator appear in [10].

Acknowledgements

The circuit described in this work was first implemented by Stephanie Jones in July 2003, under the supervision of Sarah Boyle, Department of Microelectronic Engineering, University College Cork. Brendan O'Mahony and Jim Finn, De La Salle College, Macroom, Co. Cork, assisted in verifying the robustness of the design.

References

[1] T. Matsumoto. A chaotic attractor from Chua's circuit. *IEEE Transactions on Circuits and Systems*, CAS-31:1055-1058, December 1984.

- [2] M.P. Kennedy. Three steps to chaos part I: Evolution. *IEEE Transactions on Circuits and Systems*, 40(10):640-656, October 1993.
- [3] M.P. Kennedy. Three steps to chaos part II: A Chua's circuit primer. *IEEE Transactions on Circuits and Systems*, 40(10):657-674, October 1993.
- [4] M.P. Kennedy. Adventures in bifurcations and chaos. In R.N. Madan, editor, *Chaos in Electronic Circuits*, pages 1042-1043. World Scientific, Singapore, 1993.
- [5] M.P. Kennedy. Experimental chaos from autonomous electronic circuits. *IEEE Transactions on Circuits and Systems*, 353(1701):13-32, 16 October 1995.
- [6] M. P. Kennedy. Robust op amp realization of Chua's circuit. *IEEE Transactions on Circuits and Systems*, 46(3-4):66-80, March-April 1992.
- [7] G.-Q. Zhong. Implementation of Chua's circuit with a cubic nonlinearity. *IEEE Transactions on Circuits and Systems*, 41:934-941, 1994.
- [8] A. M. Eltawil and A. S. Elwakil. Low voltage chaotic oscillator with an approximate cubic nonlinearity. *IEEE Transactions on Circuits and Systems*, vol.53(no.3):158-160, 1999.
- [9] PSpice. Pspice evaluation version 9.1. *Microelectronics Center of North Carolina*, 1997.
- [10] K. O'Donoghue, M.P. Kennedy, P. Forbes, Min Qu, and S. Jones. A fast and simple implementation of chua's oscillator with a "cubic-like" nonlinearity. *IEEE Transactions on Circuits and Systems*, 52(9):1975-1980, September 2005.

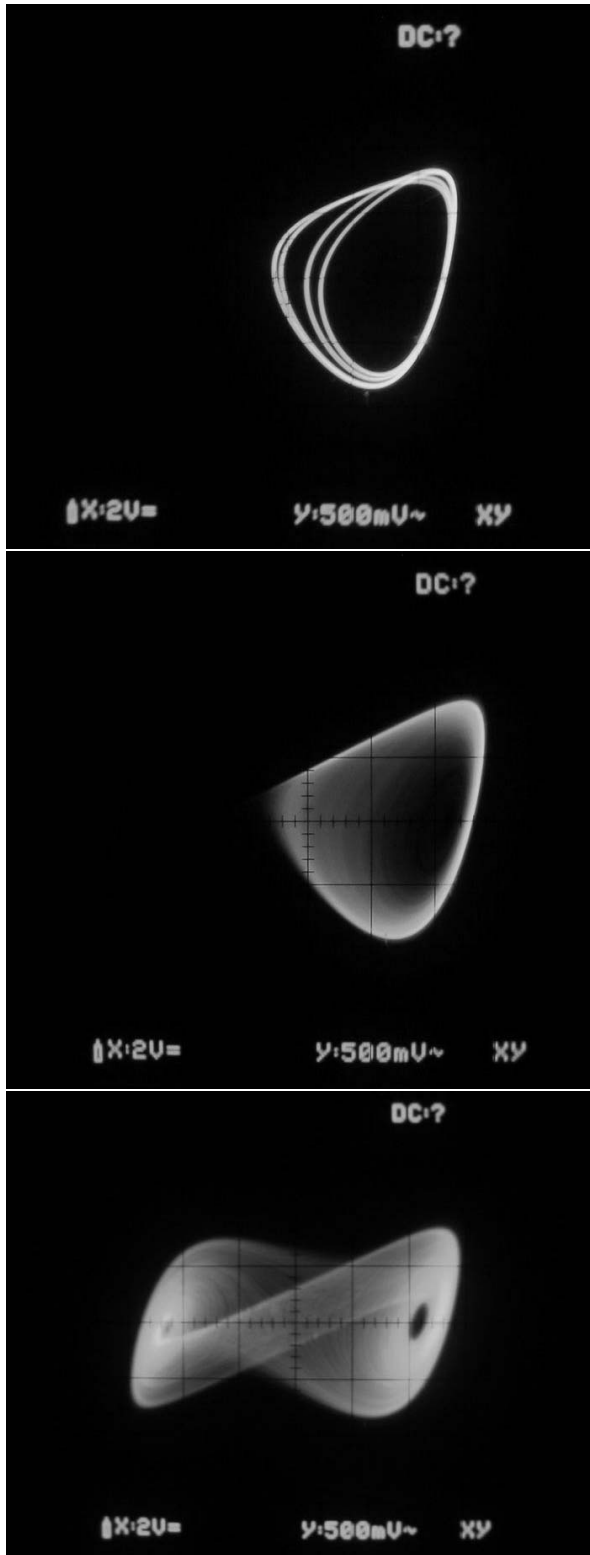

Figure 6: Measured period-4 oscillation, single-scroll and double-scroll attractors obtained from a Chua's oscillator with our cubic-like characteristic of Fig. 5 and component values $C_1 = 49$ pF (parasitic capacitance of the Chua diode), $C_2 = 537$ pF, $L = 29.4$ μ H, $R_0 = 9.17$ Ω with $R = 0.87$ k Ω (period-4), $R = 0.86$ k Ω (single-scroll) or $R = 0.85$ k Ω (double-scroll). Horizontal axis $V_1 = 2$ V/div ; Vertical axis $V_2 = 500$ mV/div. Recorded from a Hameg HM407-2 Analog Oscilloscope.

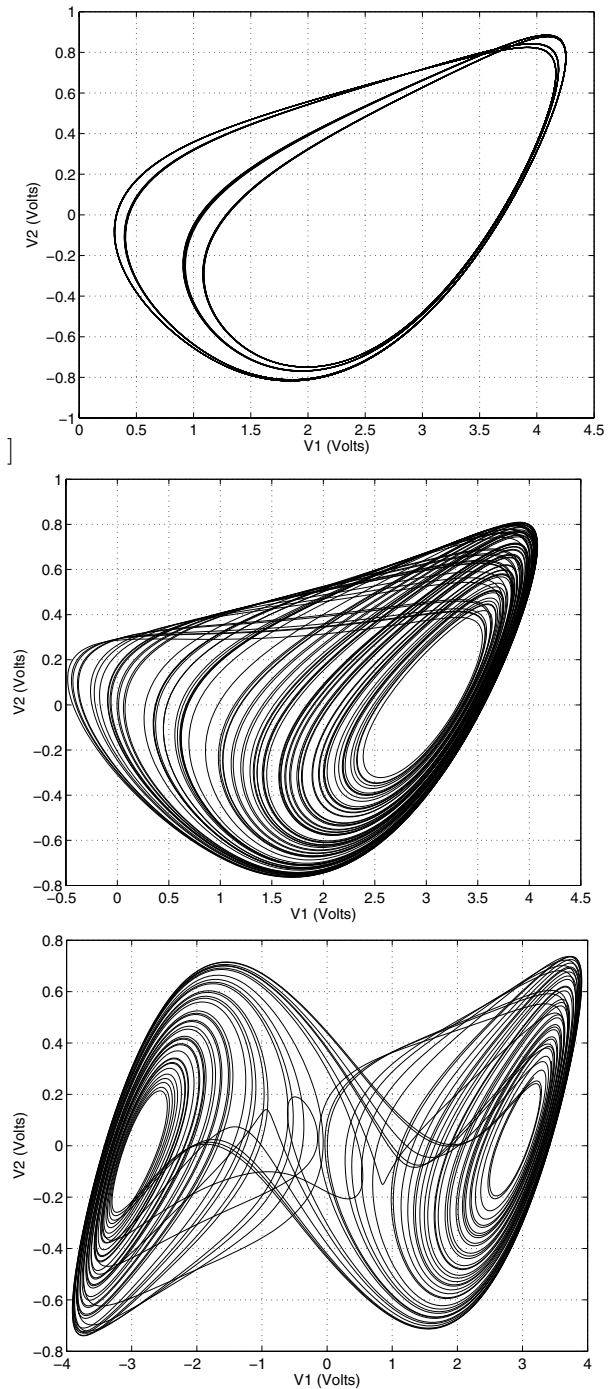

Figure 7: Simulated period-4 oscillation as well as single-scroll and double-scroll attractors obtained from PSpice by constructing a Chua circuit using our four-transistor Chua diode. Component values $C_1 = 49$ pF, $C_2 = 537$ pF, $L = 29.4$ μ H, $R_0 = 9.17$ Ω with $R = 0.922$ k Ω (period-4), $R = 0.9$ k Ω (single-scroll) or $R = 0.88$ k Ω (double-scroll); Horizontal axis V_1 ; Vertical axis V_2 .